

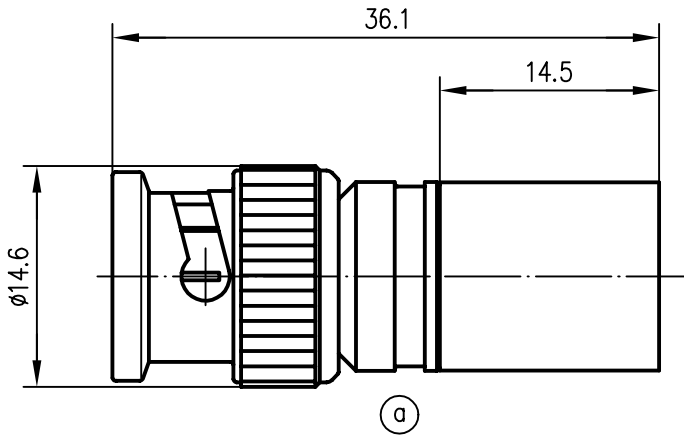
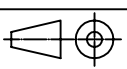

Anschlußmaße nach IEC 60169-8 /
 mating face according to IEC 60169-8



Innenleiter / inner conductor	CuZn39Pb3	Cu1Ni2Au0.8
Außenleiter / outer conductor	CuZn39Pb3	Cu2Ni5
Crimprohr / crimp ferrule	Cu SF w	Ni5
sonstige Metallteile / other metal parts	CuZn39Pb3 / GD-ZnAl4Cu1	Cu2Ni5 / Zn/Cu6Ni6
Isolierung / insulator	PTFE	
Dichtung / gasket	NBR	
Kabel / cable	RG-214/U	
Montage / assembly	A3312	

a	15978	04.10.04	BJ	2002	Datum/date	Name/name	Werkstoff/ material
				gez./drawn	13.12.	BJ	
				gepr./appr.	17.12.02	HR	Oberfläche/ finish
				Norm/stand.			
				Maßstab/scale	Benennung/title		
				2:1	BNC-Kabelstecker BNC Straight Plug		
				untol. Maße/ dim. without tolerances according to	Untert./doc.type	Zeichnungsnr./drawing no.	 Maße/dimensions: mm
				K	J01000A0060		
				Ersatz für/ replaces			Original: DIN A4